

# Earth Current Communications

*Information on this topic, both historical and practical, is given. The booklet describes the author's own experimentation; in particular, the application of amateur radio and 'natural radio' equipment to earth current communications. Later, the use of an earth base as an aerial at 73 kHz and 136 kHz is described and a theory of operation proposed.*

## Introduction

More than 35 years have passed since a friend and I first used the earth current method to communicate between our houses, as an alternative to what seemed then to be an unattainable amateur radio licence. I had read about sending signals through the earth in a book called 'The Wireless Operators Pocketbook of Information and Diagrams' by **Bishop** (1911) and seized upon this method as the solution to our communication problem.

It involved sending signals via two electrodes buried in the ground. The current would circulate over a very wide path and could be detected at a distance by two further electrodes or by a loop laid on the ground. During the First World War, the system was used to send messages through areas where shellfire would have destroyed any landline. It was originally known as the 'conduction' method, although it clearly involves induction as well. Transmission and reception are thus via '**near-field**' effects.

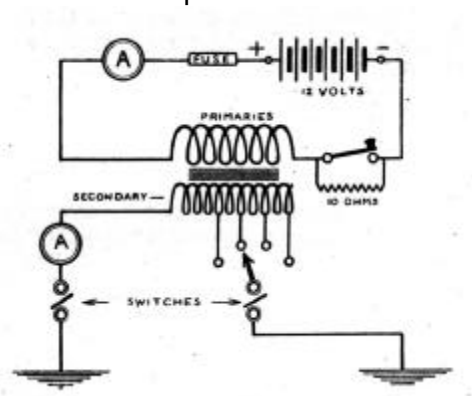

## Early experiments.

In our first tests we used an army surplus Loudspeaking Apparatus No. 9 as 'transmitter'. The high voltage output from the pair of 807s was connected directly to ground electrodes. The receiving electrodes were connected to the input of a record player amplifier. It was successful over the 200 metres between our houses, but the 50Hz hum was enormous! Since then, I have continued to come across references to the earth base method, both ancient and modern, and have carried out further work of a simple but effective nature. It is interesting to note that the study of 'whistlers' at VLF, amateur radio developments such as DSP filters, communications research by caving groups and the new frequency allocations of 73 kHz (temporary) and 136 kHz may all have a part to play in modern earth current communications.

## Some past references

**Fahie** (1901) gives a comprehensive account of the work of Preece and others in the last century to establish wireless communication by means of the 'conduction method' around various parts of Britain, often to bridge gaps separated by water e.g. to lighthouses or islands.

The method was superseded by the invention of radio, but was still used to communicate across battle zones in the First World War. **Meulstee** (1988) has written an overview of this application. The sending equipment was known as the 'Power Buzzer', an electro-mechanical device which produced 700 Hz pulsed DC at a high voltage. This was applied to the ground electrodes (which were often old bayonets) and signals sent by Morse code. Details of the theory and operation of the power buzzer system are in a textbook by **Stanley** (1919) which noted that induction as well as conduction played a role in the reception of signals. The invention of the thermionic valve enabled amplified reception and hence an increased range. The military also carried out transmission of speech via the earth.

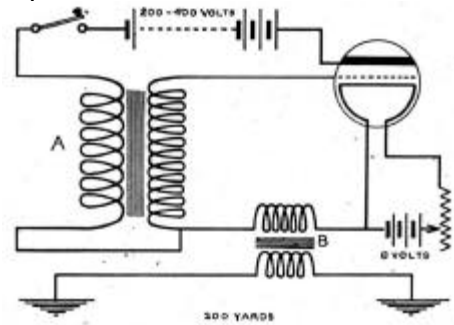

From time to time communication by means of the earth has been mentioned in the popular journals. **Kendall** (1921) revived the topic of the Power Buzzer in *Wireless World*. **QST Magazine** (1942) in their 'Experimenter's Section' encouraged the use of earth current communication for radio amateurs who were prohibited from operating during the Second World War. **Bradley** (1964 / 65) in *Practical Wireless* suggested ways of incorporating valve amplifiers for two-way speech. **Lapthorne** (1975) in *Radio Communication* examined the theory underlying the mode and suggested its use for seacoast communication. **Pickworth** (1990 / 91) renewed popular interest in the subject with a series of articles in the magazine *Electronics Today International*.

The foregoing publications will provide a wealth of other references for the enthusiast to follow up.

## Recent experimentation

The following is a summary in developmental order of my recent activities in earth communication.

My first efforts involved the application of an audio-frequency signal to two electrodes 60m apart. This was detected at a distance in excess of 500 metres, by means of a

25m earth base and also a small loop. The resistance between the transmitting electrodes was of the order of 100 ohms. The electrodes used at the transmitting base were corkscrew-type rods used to secure dog-leads to the ground. Each end had three rods connected together. The receiving base used single meat-skewers. The 500 metre range did not represent the absolute limit of my tests, but was just the 'real estate' made available to me by a local farmer.

## Transmission

First attempts to transmit speech via the earth base showed that the range was very limited compared to data and so it was decided to concentrate on the latter. Signals to be transmitted were amplified by a Realistic MPA 30 amplifier, rated at 20 watts. This unit has a 70 volt line output which was connected directly to the ground electrodes giving typically a current of 400 ma into the ground. The MPA 30 amplifier also has the advantage of working from a 12 volt supply, if required, which makes it ideal for portable operation. It appears to have a wider frequency range than that quoted in the specifications and will amplify frequencies up to 50kHz or even higher. Initial data tests used an ex-education audio signal generator connected to the amplifier to give a tuneable 'transmitter'. A BBC-B computer was brought out of retirement and operated with a data program, TX3 from **Technical Software** and the accompanying TIF-1 interface. Morse at varying speeds could be sent, the interface switching the output of the signal generator. TX3 incorporates a facility to repeat messages hence enabling the generation of a 'beacon'. One-person operation of the earth communication system was thus permitted. The TX3 program and TIF-1 interface may only be available on the second-hand market now.

The desirability of having a portable transmitting operation required an easy way of generating tones. It was found that Tandy piezo-electric sounders gave powerful tone outputs, albeit on a fixed frequency. A sounder that produced a 3670 Hz tone was used in conjunction with a Morse key. For unattended operation, a 2800 Hz pulsing unit was first used, giving a rapid series of 'beeps' which were easily detectable through the noise at the distant station.

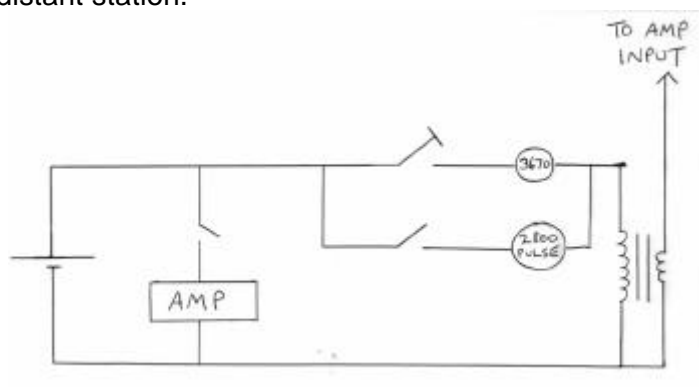

Later, a more sophisticated system used the MFJ Super Memory Keyer Model **MFJ - 493** to key the tone from a signal generator and send automatic Morse.

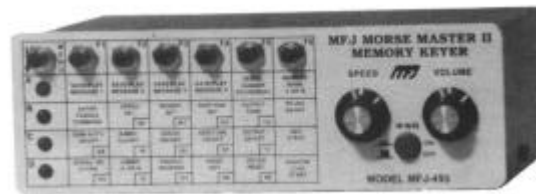

The MFJ - 493's memories can be programmed by a key, a keyboard, or a computer to send messages of the operator's choice. In addition a keyboard can be permanently plugged in, text typed being automatically converted to Morse code. The Keyer is small and light and operates on 12 volts. The output speed of the Morse from the memories can be varied. The Keyer has a key output that is used for switching DC currents. If the output from a signal generator is required to be switched, this must be done via a relay to prevent damage to the Keyer.

For portable operation, electric fencing reels available from farmers' suppliers are a very convenient way of storing the base wire.

The transmitted ground current was increased (and signals thus improved) by salting the ground around the electrodes. By putting 3kg of salt at each transmitting base electrode and pouring a bucket of water over, the resistance between the electrodes decreased from 100 ohms to 30 ohms. It thus became necessary to connect the electrodes to the amplifier's 16 ohm output to obtain a better match. Consequently signals became far stronger at the distant receiver.

### Reception by VLF Conversion.

The signal received at the distant electrodes was converted into an RF signal. The equipment used was the **Datong** VLF converter - the most sensitive of all the VLF converters on the amateur radio market that were tried.



The ground electrodes were connected directly to the input of the Datong converter - a poor impedance match that could easily be improved. The output of the converter was fed to a communications receiver (in this case a Lowe HF - 225) which was tuned to 28 MHz plus the frequency of transmission. With a 10kHz tone transmitted, the receiver, set to the CW position, was tuned to 28.010 MHz and adjusted to give audible tones of the required pitch. Strong signals were received at the test point, 500 metres from the

beacon sender. Because of interference from the mixer frequency, the Datong converter worked best with beacon tones of 5kHz or above. Automatic decoding of Morse was carried out by an **E.R.A. Mk2** Microreader. This unit, measuring just 13.5 x 11 x 5 cms. and operating from a 12 volt source, decodes data and displays it by scrolling it across an LCD screen. The audio tone from the radio must be adjusted to 1275 Hz, indicated by the centre green lighting up on the bar-graph LED frequency counter. The use of a converter and a radio receiver mean that transmitted frequencies that are towards the top or even above the range of human hearing can be converted to a suitable audio frequency for decoding by ear or machine. Later experimentation was carried out with an MFJ 462B MultiReader which also decoded CW automatically if



signals were sufficiently strong.

Good results were obtained as well with the Coherent CW system although interference from the laptop computer at the receiving end was sometimes a problem.

Instead of receiving signals from ground electrodes, the output from an amplified loop was tried with very good results. **Palomar Engineers** make a series of small receiving loops - about 20 cms. in diameter - that are used in conjunction with their portable LA -1 Loop Amplifier which is powered by a 9 volt battery.



The loop that Palomar produce for VLF work is the Omega model which covers from 10 - 40 kHz. The output of the LA - 1 amplifier was fed directly into the Datong VLF converter. With tones of 10 - 25 kHz transmitted, powerful signals were received at 500 metres. In fact, it was possible to mount the entire system - loop, amplifier, converter and receiver, in a car and drive around the neighbourhood listening to signals although it was necessary to adjust the orientation of the loop as the car travelled. It

was noted that signals were often stronger in the vicinity of telephone cables, whether the cables were above or below ground. True range readings could only be taken in more rural surroundings away from houses and roads. The loop was very susceptible to local interference such as that from a laptop computer.

### Direct reception of audio tones

Pickworth (1990 ) describes the use of a 'tuned earth receiver' to maximise the received signal and to cut out interference such as 50 Hz hum. Working along these lines, an ex-education Unilab de-mountable transformer was obtained. This apparatus had two 300 - 0 - 300 coils. These were placed side by side and a core made from 15 ferrite rods of the sort used for LW / MW radios. The inductance of one of the coils was now 65 mH. To tune over a frequency range of 700 Hz to 13,000 Hz - albeit not necessarily efficiently - required capacitance in parallel to be switched in from about 2 nF to 1100 nF. At first this appeared to need an inordinately complex arrangement. However, remembering the values of the sets of weights for chemical balances, the solution was soon apparent. Three banks of 4 switches were constructed to bring in the following nF values, made from a combination of capacitors (it is important to measure the real value of these capacitors rather than trust the value stated on the case).

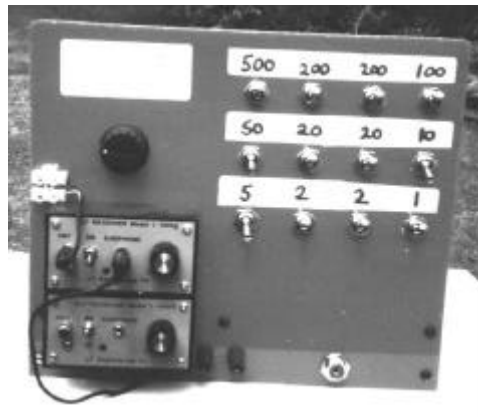

**500,200,200,100    50,20,20,10    5,2,2,1** Any value in the required range may therefore be selected by choosing the appropriate switch combination. No doubt the arrangement could be further simplified by the use of rotary switches.

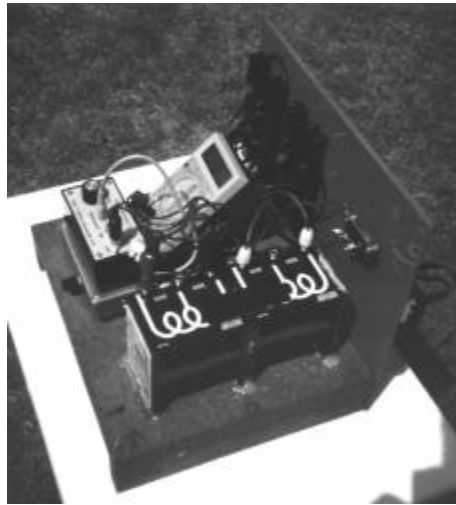

The input from the ground electrodes is applied to the primary coil. The secondary coil is connected to a high gain amplifier and the signal peaked by operating the switches. The receiver can be calibrated by means of a signal generator.

The author's interest in 'whistlers' had led to obtaining a small (1.5 x 6.5 x 3.7 cm.) VLF whistler receiver, the WR3 from **S.P. McGreevy Productions**.



This handheld receiver is optimised for reception in the 0 to 10kHz range and has a 1 metre - long whip antenna. It had been noted that this receiver would detect the transmitted beacon tones simply by touching the whip to the ground at various distances - up to several hundred metres - from the transmitting electrodes. It was substituted for the amplifier in the 'tuned earth receiver' and gave excellent results.

**LF Engineering Co.** produce a variety of receivers for 'natural radio' and several of these units were obtained for experimentation. Their dimensions are 10.2 x 5.4 x 4.2 cm.



The L - 600S H-Field Receiving System which uses a 60 cm. sided square loop was the most effective at receiving beacon signals in the 6kHz region. The output from the LF Engineering receiver was later fed to the 'tuned earth receiver' and was thus further boosted with an improvement in signal strength. Experiments were also carried out with another product from LF Engineering, the L - 500L ELF/VLF Longwire Receiving System, and results looked promising. All these receivers are powered by an internal 9 volt battery.

### Audio filtering

The output from the 'tuned earth receiver' or the radio receiver was further improved by passing it through an audio filter.

The Datong FL3 Multi-mode Audio Filter covers a range of 200 - 4000 Hz and will peak up tones. A most worthwhile improvement was obtained but as with any peak filter, excessive peaking resulted in 'ringing' and a consequent degradation of signals.



It was decided to try the latest amateur radio DSP technology in the form of the MFJ Super DSP Filter Model MFJ - 784

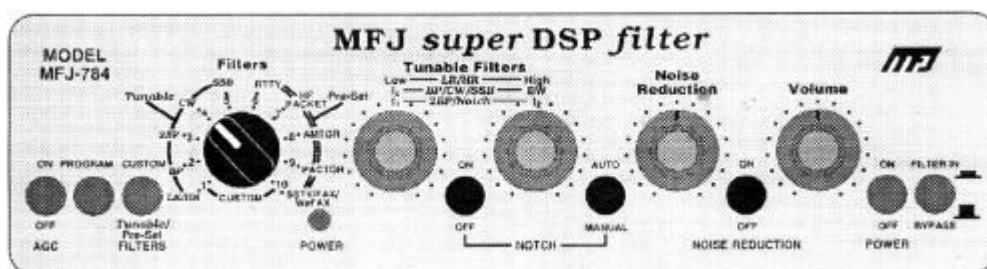

This is a tuneable DSP filter for amateur radio, covering 250 - 3500 Hz and incorporating a random noise reduction filter. Results from this filter surpassed those from the Datong unit.

### Caution

The use of high amplification brings about risks of feedback. The use of speakers may produce intense magnetic fields that may interact with the coils of the 'tuned earth



receiver' and give howl-round. The MFJ - 784 is slightly microphonic and needs to be placed away from any vibrations. The use of headphones may seem a solution but care must be exercised when moving close to input coils as even the small fields from the 'phones may be detected and deafening oscillations set up.

## Summary

The use of amateur radio and 'natural radio' equipment was found to be most effective in the improvement of reception of signals from the ground. The advent of inexpensive solid state amplifiers like the 1 kW amplifier from **BK Electronics** mean that signals of great intensity may be 'injected' into the ground.

## 73 kHz transmission with a ground antenna.

The BK Electronics 1 kW amplifier is rated to 100kHz and it was therefore considered that it would be interesting to attempt the transmission of 73kHz via 'ground electrodes'. The results were most rewarding. The first VFO consisted of an signal generator set to a suitable frequency in the 73kHz band. It was found necessary to add a low -value variable capacitor on one side of the Wien bridge to enable sufficiently slow tuning. A Fluke 8060A DMM was used to give an accurate readout of the transmission frequency, and a local communications receiver gave verification. This 73kHz signal was switched (via a relay) by an MFJ Super Memory CW Keyer. This device enabled the setting-up of beacon text in memory as well as direct keyboard entry. The CW signal was fed into the 1kW amplifier. The amplifier output was connected to the primary of a step-up transformer custom built by **Sowter Ltd**. The primary winding was designed for a 2 ohm input, the optimum for the BK Electronics amplifier. The secondary windings were switchable to give output impedances of 10, 40, 160 and 250 ohms. These values had been empirically decided. The transformer's output was connected to ground electrodes - proprietary mains earth rods about 1.5 metres in length - which were approximately 230 metres apart. The near electrode was a 5cm. aluminium tube hammered about 1.75 metres into the ground. The far electrode consisted of two copper rods 4 metres apart and linked together. The immediate ground around both electrodes, near and far, was salted (about 3 kg. per site) and watered. This gave a resistance between near and far of 20 ohms varying daily according to the weather conditions. It can be shown that the resistance between two electrodes in a uniform conductor is independent of the distance between them - this is a consequence of the multiple paths of the current. Ground resistance is measured by a portable unit. A small 12v lead-acid battery powers a 110v inverter, the output from which enters a 240v to 110v transformer. The 50 volt output is sufficient to drive a current of up to 2 amperes through this ground system. A White Gold meter is connected in such a way so that it measures both voltage and current without disturbing connections. It is only necessary to turn the meter switch to read V and A. A calculator is also attached for ready impedance calculation.

The portable receiving system at G0AKN was a Palomar WWVB loop, together with a Palomar loop amplifier and a Lowe HF 225 receiver. An MFJ Tunable DSP filter was

used to improve weak signals. With the amplifier at mid-power setting, reception at a distance of over 16 kms. was initially achieved. This was followed by good reports from G4GVC in Leicester - about 100 kms. distant. **'Far-field'** effects were clearly responsible for propagation. The distant receiving antenna (belonging to G4GVC) is in a NE-SW direction. The author's 'earth base' is also aligned NE-SW though this may not be relevant to the success.

**Electro-Inductors Ltd.** of Croydon kindly loaned the author a Wayne-Kerr inductance analyser to explore the characteristics of the ground electrode system. The ground circuit exhibited complex behaviour. Both AC and DC currents flowed and this hindered measurements. It appeared that the impedance of the system increased with frequency, possibly a consequence of the reactance of the inductance of the mass of ground and the wire, and increasing resistance of the earth path because of the 'skin effect'. The system also appeared to exhibit capacitance. Preliminary tests showed that it was possible to 'tune out' the inductance with a small capacitor and obtain a doubling of ground current.

#### **More on the Wayne-Kerr inductance analyser tests.**

It was difficult to get steady readings as currents both AC and DC were present in the circuit. There are electrochemical effects at the electrodes. Also outside the house is an 11,000 volt substation fed by overhead wires that run near the 'ground system'. In addition, instability showed up at 60kHz - possibly the Rugby signals. At any rate, connection of the WK to the ground showed clearly that the impedance of the circuit varied widely with frequency. WK measurements were eventually made through the coupling transformer and, knowing the chosen impedance ratio, the impedance of the ground was calculated.

Whether the maximum secondary/primary ratio or some of the taps were used, the same overall effect was observed, albeit the numbers were different. With the 230 metre base, the impedance rose rapidly as the frequency increased. Using the full secondary windings, ground impedance was 21 ohms at 1kHz, 39 ohms at 6 kHz, 231 ohms at 40kHz, rising to 680 ohms at 73 kHz. The next measurement was at 100kHz. Here the impedance had fallen to 330 ohms. However, somewhere between 200 and 300 kHz it began to rise again. At 300kHz, the machine's maximum, it was over 500 ohms. When it came to transmitting on 73kHz, it was found that the full secondary winding of the coupling transformer gave the best match to the ground, unlike at lower (audio) frequencies. The addition of 2 or 3 nF in the circuit greatly increased the current (and led to a stronger signal received at G4GVC). However, there were some days when additional capacitance greatly **decreased** current. In the old 'earth conduction' experiments of the last century where tones of 800 Hz or so were sent via loops of telephone wires with distant ends which were earthed, the same phenomenon of reactance was observed and microfarads of capacitance were added to increase the current and hence the signal received.

## Experiments at G3HMO's Devon QTH - August 1997.



G3HMO in Devon - wire overhead.

Further work was carried out in August by G3HMO and GOAKN on the use of a 'ground antenna' for 73kHz transmission. At G3HMO's cliff-top Devon residence, two leads were taken from the shack down to the sea, each end terminating in a tin that had been soldered on and weighted down with a large pebble inside. These were thrown into the sea at low tide. The tins were about 200 metres apart in the ocean and each leg from the shack was of a similar distance. The resistance, or more correctly the impedance, between the two grounds was approximately 25 ohms. Owing to D.C. electrical potentials and also induced mains currents, the impedance was measured by putting 12 to 24 volts A.C. across the electrodes and measuring the current flow. A battery powered signal generator acted as VFO and was amplified by a 20 watt Realistic MPA 30 amplifier which operated on 12 volts. The signal was modulated by the Precision CW program for Coherent CW to provide a beacon and a Watson Senda interface used between the laptop and signal generator. An interrupted current of 50mA into the ground was detected at approximately 2 km. by the usual receiving system - a Palomar loop and amplifier combination connected to a Lowe HF 225 receiver. Once again the phenomenon of inductance was observed. The 'ground loop' had an inductance of around 2mH. It was possible to increase the current in the ground loop threefold by the addition of a few nanofarads in series and thus gain more S-points on the received signal. In this experiment at G3HMO's there was clearly a large length of wire above the ground, suspended on hedges and sweeping down to the sea over the cliff. However it is interesting to note that at GOAKN's QTH the wires to the ground electrodes lie along or under the soil and that there is still an inductance of 1.5 mH. It would appear that much of the 'loop' is thus formed by the current paths under the ground (or sea). By the way, the most essential part of the equipment for laying the system at G3HMO's was a 3 metre bamboo pole, terminating in a forked wire made from a coat hanger. This was used to lift lengths of cable up into hedges and trees, away from members of the public who saw it as their duty, on one occasion, to reel up our wire and toss it over the cliff !



A pair of 16 ohm communication headphones were connected to the ground electrodes for interest's sake. S9 QRN from three electric fences was heard, non synchronized with about a 1 second period. On one evening - without any amplification - showers of "'tweeks' were heard. The signal was amplified and recorded for 30 minutes, resulting in our first 'whistler' being detected.

### **136 kHz transmission with a ground antenna.**

The signal generator did not operate above 100 kHz and reception reports indicated that in any case it was insufficiently stable for more demanding LF work. A crystal controlled VFO was constructed giving 500mV output and was BPSK modulated using the VE2IQ Coherent program. The modulated oscillator output was fed into the same BK Electronics 1 kW amplifier and thence via the transformer to the ground electrodes. The standard version of the BK Electronics amplifier is rated by the manufacturer to operate up to 100kHz. In practice the author has found it capable of amplifying at 136 kHz with no modification.

The impedance of the ground system varied from as low as 18 ohms at 50 Hz to 500 ohms at 73 kHz, but curiously descended to 90 ohms at 136 kHz. Changes in the weather conditions were noted to cause large fluctuations in the impedance. To cope with this, a transformer with a tapped secondary was required to match the amplifier to the ground. The taps were selected for maximum current output and gave a range from 40 ohms to 800 ohms. The ferrite transformer was designed and made by Electro-Inductors of Croydon. Currents into the soil were occasionally greater than 1 ampere. The ground system sometimes exhibited inductance and the addition of a few nanofarads of series capacitance brought about a sizeable increase in ground current with a consequent increase in signal strength reported at the receiving station. RS Components 'impulse' capacitors proved satisfactory for this task. Very high voltages

can develop across these series capacitors and across the output to the electrodes, so great care should be taken when transmitting. The siting of the leads to the electrodes also needs care to avoid the risk of shock or of being tripped up.

On transmitting at 136.5 kHz a lower ratio was needed on the coupling transformer than at 73 kHz. The addition of up to 10 nF sometimes gave a worthwhile current increase in the ground circuit at this higher frequency. Reception at a distance of over 393 kms. has been achieved at 136 kHz.

#### **Further details on the earth base.**

The total wire used to get back to the shed from the Far Electrode is about 400m - 2.5mm stranded mains wire is used. The wire from the Far Electrode crosses a footpath and a neighbours plot. It is estimated that about 15m of the wire is above ground level, at a height not exceeding 4m. The rest of the wire is laid on the ground. The impedance at 50Hz between the two electrodes is usually 21 ohms and stays fairly constant, +/- 3 ohms, depending on the weather. No doubt the salt is leaching away from the vicinity of the electrodes but, if so, it might just be producing a larger volume of very conductive soil. There is a nearer set of electrodes at about 80 metres from the QTH, from previous tests. The soil is a rich humus over clay, with chalk down there somewhere - we are near the Chilterns.

The same WK tests were carried out with the 80 metre electrodes. Here the same impedance variation began to show. At 1kHz the closer electrodes had an impedance of 21 ohms as before, at 40 kHz it was 124 ohms, whilst at 73kHz it was 340 ohms. However, the impedance continued to rise and did not drop until somewhere after 200 kHz. At 200 kHz it was 735 ohms but at 300 kHz the impedance was 340 ohms.

#### **The 1998 tests at G3HMO's Devon QTH.**

The aim of these tests was to investigate the transmission properties of a much longer earth base than the 230 metres in Oxfordshire. A colleague kindly provided 1000 metres of 32/0.2mm wire and a further 500 metres of slightly thinner stranded wire was located in my 'stock'. G3HMO had looked over maps of the chosen area and had found a long private road whose owners he knew. This was to minimise the risk of damage to the wire from passers-by.

We visited the site on 1st. August and commenced hammering the 1.2 metre earth rods into the soil. It was only possible to get the rods in a few

centimetres owing to the local rock formation so we drove two rods about 5 metres apart into a nearby bank of earth at a shallow angle. It was difficult to salt and water these rods and the resistance between them was shown to be 500 ohms. We searched around the site and found one other place where we were able to drive a rod fully in vertically. This was salted (1kg.) and 25 litres of water applied. For good measure we connected the other two rods to this rod. This was to be the site of the station.

1,500 metres of wire was then laboriously laid out along the ground by the side of the twisting Devonshire lane. At the far point – part way down a hill – the ground at the side of the road rose in a steep bank. A plateau was found where it was possible to get a rod in vertically. Only a metre entered despite a hefty sledge-hammering. The area was salted and watered but the lie of the land meant that the solution drained off rapidly. We had no more rods so returned to 'base' to measure the resistance. The distance between the earth points was measured by GPS receiver as 0.85 mile. Using my portable 50 volt AC system, resistance was found to be 190 ohms. The wire accounted for approximately 35 ohms of this. I am sure that this base resistance could be substantially lowered by better contacts with the ground.



On the 2nd. August in the early morning drizzle we set up the transmitter (the 1kW amplifier feeding the Sowter output transformer) powered by the Briggs and Stratton 2.2 kW generator. The generator's output was fed through a spike protector extension lead and then through a device that measured power consumption. A Fluke 8060A meter was placed in series with the amplifier output. We transmitted for 45 minutes on 136.5 at 10.00 local and for a further 45 minutes at 11.00 local on 72.05 kHz. It was possible to exceed 630mA at 136.5kHz into the earth system and over 1A at 72.05kHz. The amplifier drew 600 watts at 136.5 kHz and 800 watts at 72.05kHz. One amusing phenomenon was the roar of the generator's exhaust being CW modulated! I tape-recorded this for posterity. It was gratifying to hear later that our signals on 136.5 kHz had been heard by G4GVC portable at

Woburn (250kms.) and by others at the Crawley club G3WSC station. The WX was excellent later that day.

I experimented also with 6kHz and was able to send 1.5A into the ground. The system power consumption was 1.2 kW at that frequency.

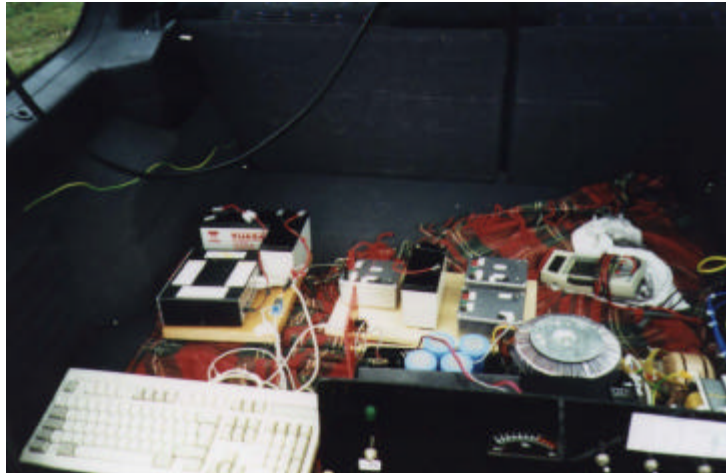

#### **Earth Bipole summary and tentative theory.**

1. An earth base whose earth rods are only 230 metres apart is capable of radiating electromagnetic energy at frequencies of 73 kHz and 136 kHz, despite the fact that the wavelength of radiation at these frequencies is 4,100 metres and 2,200 metres respectively. This has been demonstrated on numerous occasions. There is some evidence for directionality. The bulk of the line is on or under the ground. It has been shown experimentally that the impedance presented to the output of the transmitting amplifier when 136 kHz is used is much lower than at 73 kHz.
2. The resistance between the rods at 50Hz is around 28 ohms at the G0AKN site. A more detailed examination showed that this resistance (more properly called impedance) steadily increases with the frequency of current fed to the rods, reaching a maximum. If the frequency continues to increase the impedance decreases to a minimum and then rises again. Readings appear to vary with weather conditions. There are multiple current paths in the soil - the depth of these depend upon the skin depth at the frequency in use. Adding capacitance to the circuit has increased the current sometimes - but not always. There may be other factors such as inductance of the ground and skin effect in the wire.
3. The maximum and minimum impedances vary with the length of the base. Measurements taken in April 1997 showed that the first maximum peak of impedance occurred at a frequency of approximately 200 kHz with an 80 metre base, whilst on the same day with a base of 230 metres the peak was at approximately 75 kHz.

## 230m and 80m spacing

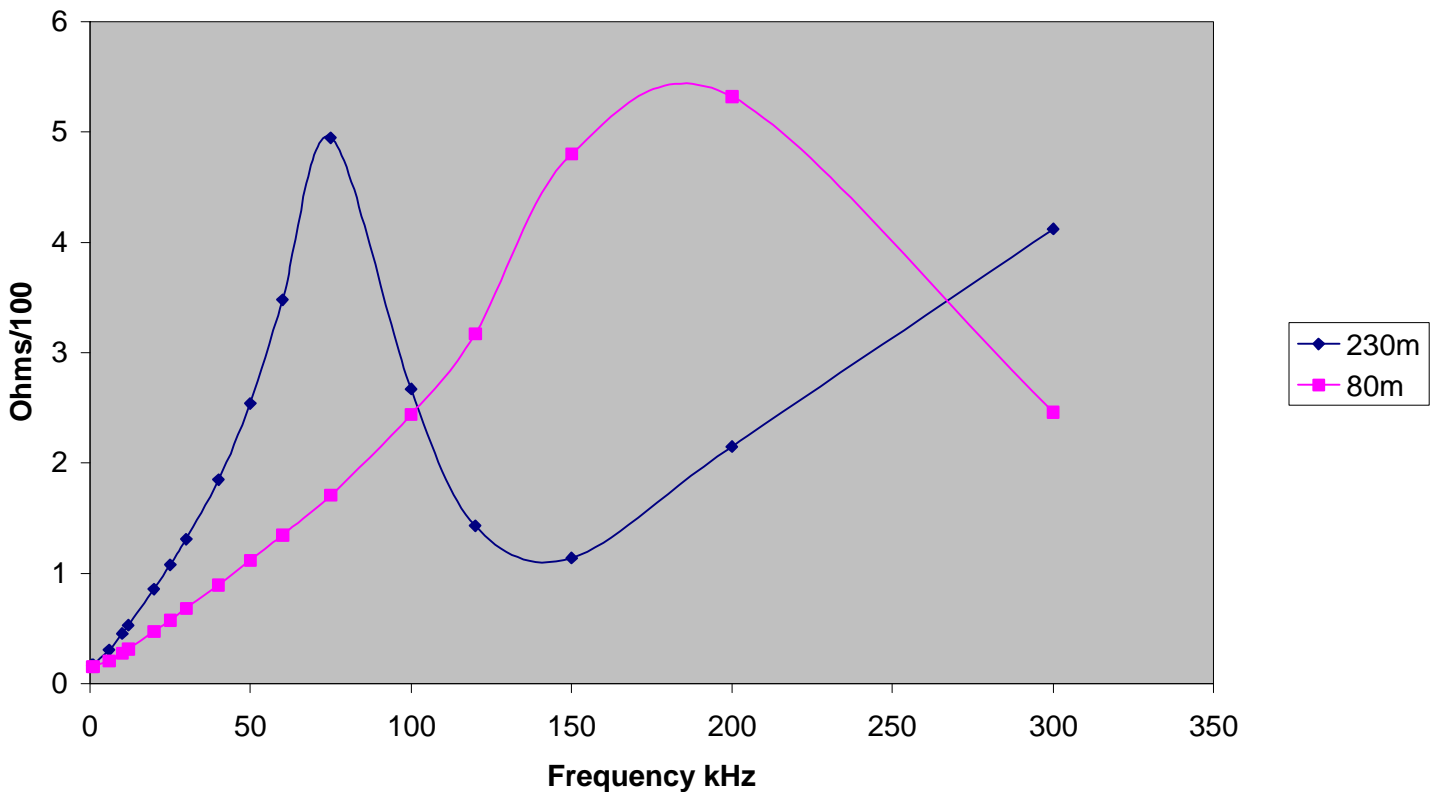

4. The behaviour of a long line close to the earth resembles that of a transmission line. A transmission line shorted at one end has points of maximum and minimum reactance spaced one quarter of a wavelength apart. The reactance is alternately inductive and capacitive. (*J.K.Hardy 1986*)

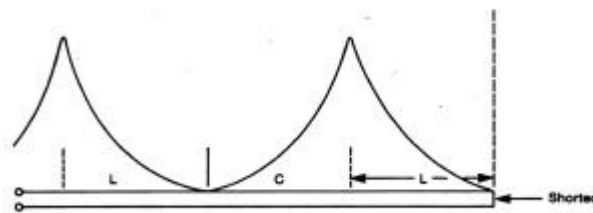

5. Using this approach the 80 metre base represented  $\lambda/4$  at 200 kHz. 230 metres represented  $\lambda/4$  at 75 kHz. Thus the 200 kHz radiation had a wavelength of 320 metres in the ground and the 75 kHz radiation a wavelength of 920 metres in ground.

6. The velocity of electromagnetic radiation in a medium is dependent upon the dielectric constant of that medium. The dielectric constant of a vacuum is 1. Geology texts give the value of the dielectric constant for soil to be between 3.9 (dry soil) and 29 (moist soil). That of clay varies from 7 to 43. Water has a dielectric constant of 81. If  $u$  = velocity of electromagnetic radiation in the medium and  $d$  = dielectric constant,  $u = 300,000,000/\sqrt{d}$ . If  $f$  = frequency then because  $\lambda = \text{velocity of radiation}/f$  we can



calculate the dielectric constant. Substituting the wavelengths obtained above we find that 'd' is 22 and 19 respectively - a very good agreement.

7. In order to get a low impedance presented to the amplifier, the length of base should therefore be  $\lambda/2$ . Using  $d = 20$  this means that the base length should be about 250 metres at 136 kHz and about 460 metres at 73 kHz.

8. The dielectric constant will vary with the nature of the ground and its water content.

9. The circuit may require added inductance or capacitance to allow more current to flow.

10. A chance discovery recently in a 1918 'wireless' text showed that there had been experimentation with transmitting through long wires close to the ground in 1911 (except that the wires were either connected to the earth plates via 2nF capacitors (Leyden jars, of course) or left unattached). The aerials were said to be very directional.

11. Signals on 136 kHz from a 0.85 mile base (that was not correctly matched to the amplifier output) this summer were received clearly on a 1 metre loop system at 250 km. It was noted at the time that the base impedance was also higher at 73 kHz than at 136 kHz.

12. Because the wavelength is shorter in the ground, current loops in the earth may achieve  $\lambda/2$  or greater even with very short bases.

13. Work on Beverage aerials for transmitting VLF (Project Sanguine) showed that where the length of the aerial was very much greater than the skin depth of the conductor at the VLF frequency (at least a factor of 10), then the 'effective depth' of the return current played a significant part in the function of the aerial.

$f$  = frequency (Hz)     $\sigma$  = ground conductivity (Siemens)     $\delta$  = skin depth

$$\delta \cong 500/\sqrt{(\sigma \times f)} \text{ and the effective return current depth is } \delta/\sqrt{2}$$

Ground of poor conductivity,  $\sigma = 0.001$

Ground of average conductivity,  $\sigma = 0.005$

Ground of good conductivity,  $\sigma = 0.01$

At 136.5 kHz, the calculated return current depth varies between 43 metres (poor soil) and 13.5 metres (good soil).

Reports from listening stations indicated that the best signals were received on dry days. The current (normally related to received signal strength given) was often at the highest on a wet day. However, signal strength received was usually down or the signal was not heard on those days. It may be that the current loops are constrained more tightly and do not approach  $\lambda/2$  on very wet days.

Good contact between the ground and the electrodes has been shown to be necessary to enable a high circuit current. Salting the electrode sites made a very large difference. Two rods in the earth have been shown to have a very much lower contact resistance than one. Work in this area of multiple electrodes has been carried out by **Gibson, Gill and Rabson**, '*Combating Earth Electrode Resistance*' published in the Journal of the Cave Radio and Electronics Group. Other CREG Journals contain valuable information on earth current transmission since it is one of the communication modes that cavers use.

14. The ground circuit appears to exhibit a similar variation in impedance at HF. An Autek RF Analyst Model RF1 was connected to the ground via a 4:1 balun. Peaks and troughs of impedance were shown to occur as the frequency was increased but there was no obvious correlation.

### **Work in progress.**

The results from the Wayne Kerr inductance analyser in 1997 led to another approach this year.



The output of a battery operated signal generator which covers 10 Hz to 209 kHz is fed to the 1 kW amp and the latter's output into the ground is measured at a variety of frequencies. A Fluke 8060A meter is placed in series for current measurement. The peak voltage across the ground electrodes is measured with an ordinary DMM which is connected via a high-voltage silicon diode and 0.1 $\mu$ F capacitor. Frequency is measured using the Watson Super Hunter counter from **Waters and Stanton** - a useful device which has a range from 10 Hz to 3 GHz.

The computer program Excel is set up to calculate rms volts and impedance and to plot a graph of frequency versus impedance. A typical result is shown.

F vs R test 2

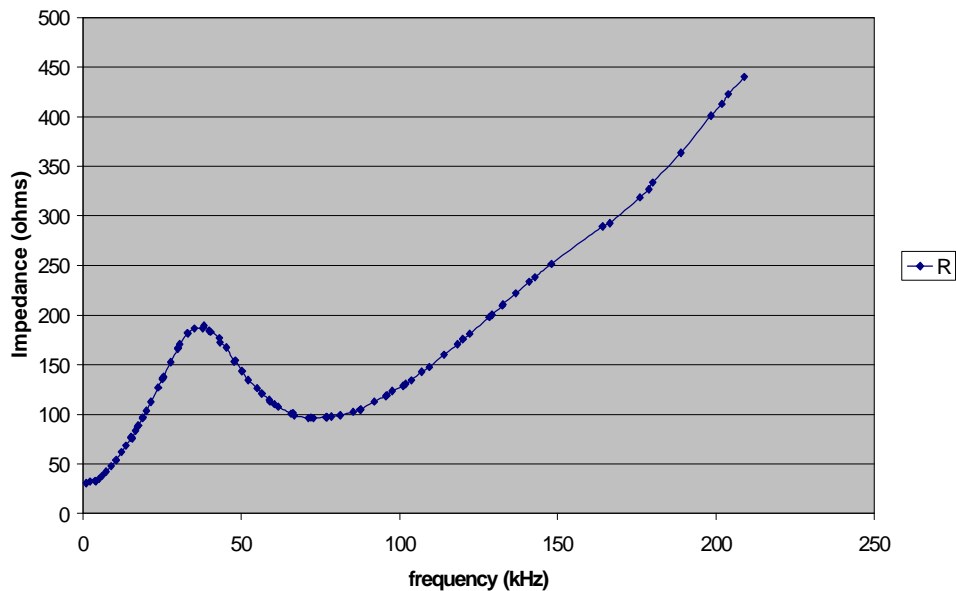

The latest tests involve connecting an oscilloscope across the amplifier output to the electrodes. The Y deflection thus gives a measure of voltage. The External X input is connected across a 10 ohm resistor in series with the electrode circuit and the measured voltage is proportional, therefore, to the current flowing in the ground. The resulting Lissajous figure is studied at different frequencies. The results show that at the impedance peak and trough, the load becomes resistive. The Lissajous ellipse changes to a straight line at those points. This seems to indicate some form of resonance. The gradient gives a relative measure of the voltage to current ratio. Study of the ellipse will show what proportion of the load is resistive and what is reactive. More work is scheduled to take place ideally over a wider range of frequencies and over a longer base. A 500m base has been selected in Oxfordshire for further tests.

**October 1998**  
**JOHN TAYLOR G0AKN**

## **Bibliography**

Bishop, Leon *'The Wireless Operators Pocketbook of Information and Diagrams'*, Bubier Publishing Co. 1911.

Fahie, J.J *'A History of Wireless Telegraphy 1838 - 1899'*. William Blackwood and Sons. 1901.  
 pp 1-5, 130 - 176.

Rabson (& Gibson and Gill) '*Cave Radio and Electronics Group*' Journal 33, Sept. 1998

Hardy, James K. '*Electronics Communications Technology*'. Prentice / Hall International Inc. 1986  
p. 331

IEEE Transactions on Communication Vol. Com-22, No.4, April 1974  
'*Early Development of the Project Sanguine Radiating System*' B.E.Keiser

Meulstee, Louis '*Earth Current Signalling. The History of the Power Buzzer*'. Journal of the Royal Signals, Spring 1988.

Stanley, Rupert '*Textbook on Wireless Telegraphy*', Vol. 2. Wireless Press. 1919.

Kendall, G.P '*Earth Wireless, Some Notes on the Power Buzzer*'. Vol. IX, Wireless World. 1921. pp 409 - 411.

QST Magazine. '*Experimenter's Section*' April to October inclusive. 1942.

Bradley, C.R. '*Communications Through The Ground*' Practical Wireless May 1964.  
'*Improved Communications Through The Ground*' Practical Wireless February 1965.

Lapthorne, R. '*Radio communications at frequencies below 10kHz*'  
Radio Communication April 1975

Pickworth, G. '*Earth Current Signalling*' Electronics Today International  
February, March, April, June 1990.

*VLF Earth Loop Antennas*  
(Parts 1 and 2) Electronics Today International  
April, May 1991

*LF Experimenter's Source Book (2nd. Edition)*  
from Radio Society of Great Britain  
Cranborne Road  
Potters Bar  
Herts EN6 3JE

## **Addresses**

Technical Software Ltd.  
Fron  
Upper Llandwrog  
Caernarfon  
Gwynedd LL54 7RF

MFJ-462B, MFJ - 493 and MFJ - 784 from:  
Waters and Stanton Ltd.

22 Main Rd, Hockley, Essex SS5 4QS

Datong Electronics Ltd  
Clayton Wood Close  
West Park  
Leeds LS16 6QE

E.R.A Ltd  
Unit 26, Clarendon Court  
Winwick Quay  
Warrington  
Cheshire WA2 8QP

Palomar Engineers  
P.O Box 462222  
Escondido  
California 92046  
USA

S.P.McGreevy Productions  
45 Elda Drive  
San Rafael  
CA 94903 - 3723  
USA

LF Engineering Co. Inc.  
17 Jeffry Road  
East Haven CT 06513. USA  
BK Electronics  
Units 1 and 5  
Comet Way  
Southend on Sea SS2 6TR

EA Sowter Ltd  
PO Box 36  
Ipswich IP1 2EL

Electro-Inductors Ltd. / Aluminium Inductors Ltd.  
29 Lower Coombe Street  
Croydon  
Surrey CR0 1AA  
<http://homepages.tesco.net/~electro.inductors/>